

**STANDARD PROFILE KNIVES IN "SP" STEEL - height 50x4 mm
(RELATING LIMITERS)**

**Example:
Knife SA2..
Limiter (SA3..)**

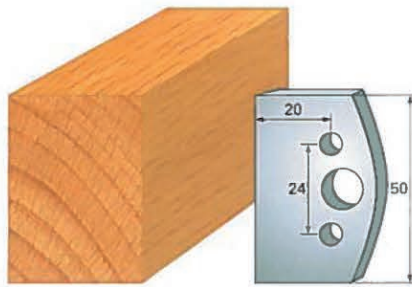

Art. SA2000 - (SA3000)

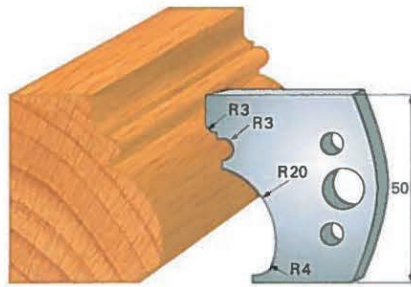

Art. SA2001 - (SA3001)

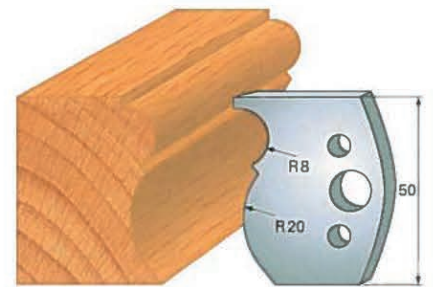

Art. SA2002 - (SA3002)

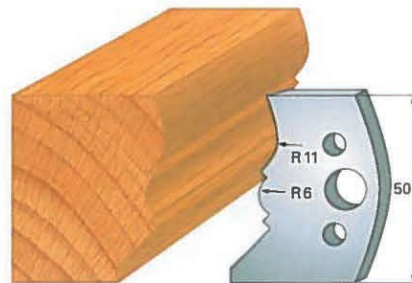

Art. SA2003 - (SA3003)

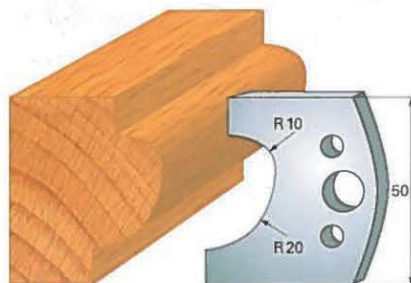

Art. SA2004 - (SA3004)

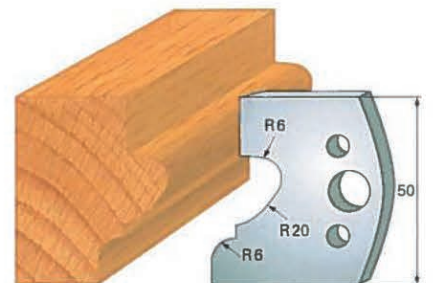

Art. SA2005 - (SA3005)

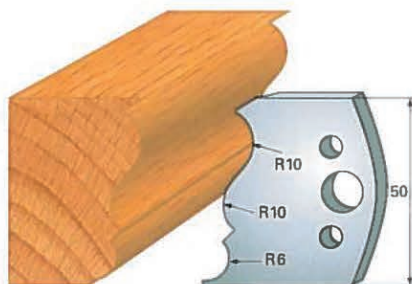

Art. SA2006 - (SA3006)

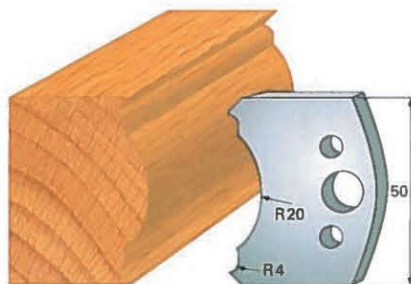

Art. SA2007 - (SA3007)

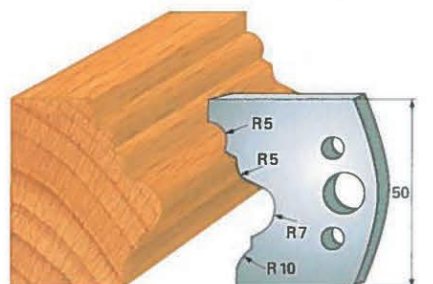

Art. SA2008 - (SA3008)

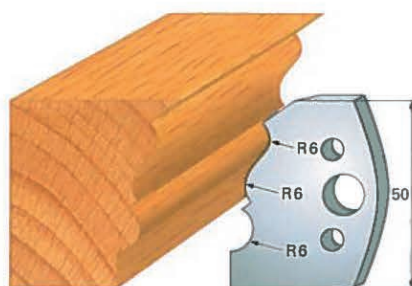

Art. SA2009 - (SA3009)

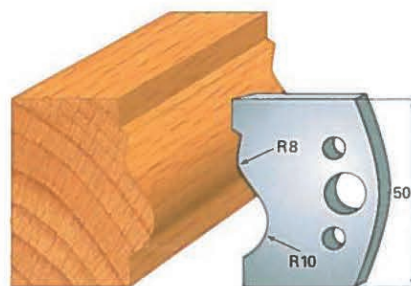

Art. SA2010 - (SA3010)

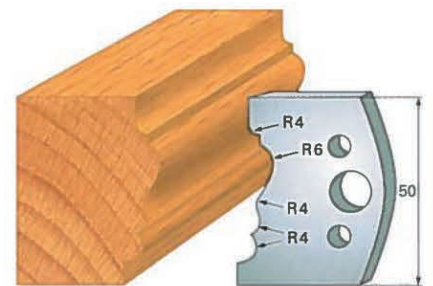

Art. SA2011 - (SA3011)

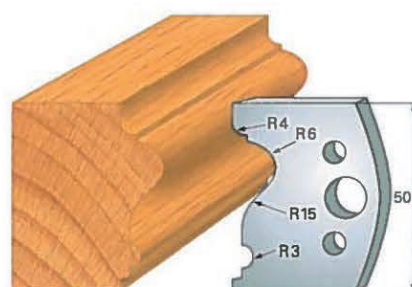

Art. SA2012 - (SA3012)

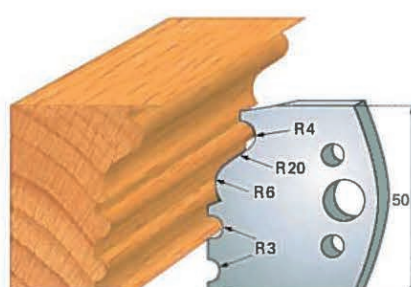

Art. SA2013 - (SA3013)

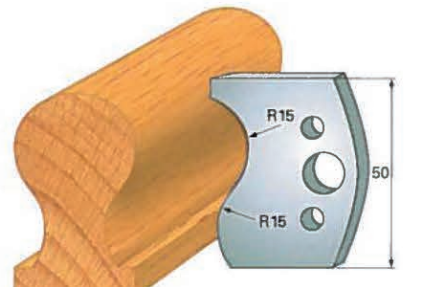

Art. SA2014 - (SA3014)

**STANDARD PROFILE KNIVES IN "SP" STEEL - height 50x4 mm
(RELATING LIMITERS)**

**Example:
Knife SA2..
Limiter (SA3..)**

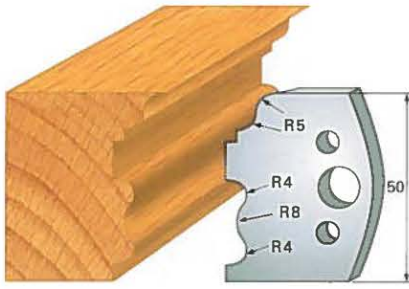

Art. SA2015 - (SA3015)

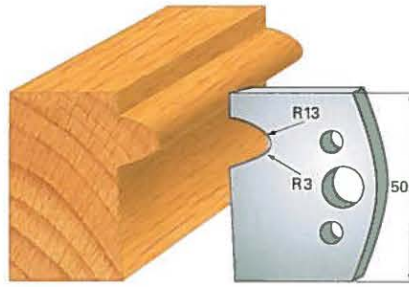

Art. SA2016 - (SA3016)

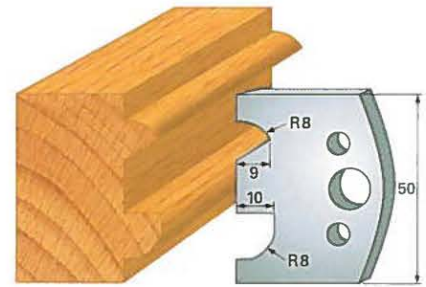

Art. SA2017 - (SA3017)

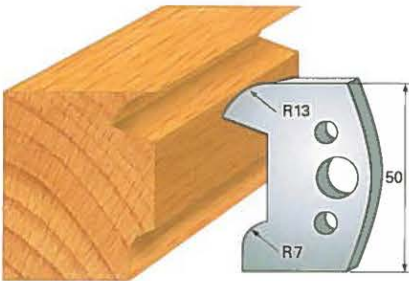

Art. SA2018 - (SA3018)

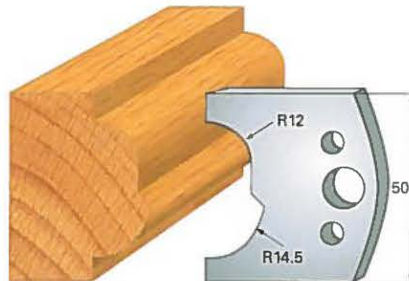

Art. SA2019 - (SA3019)

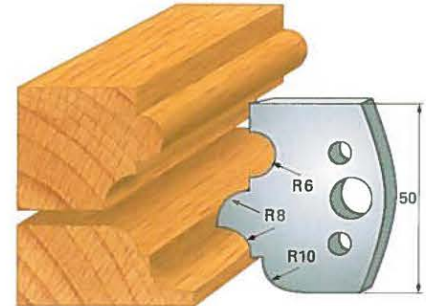

Art. SA2020 - (SA3020)

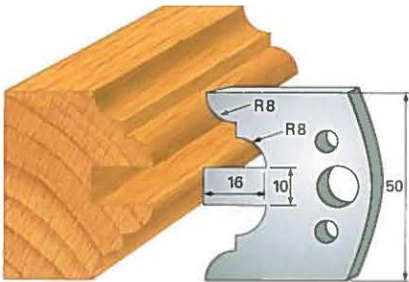

Art. SA2022 - (SA3022)

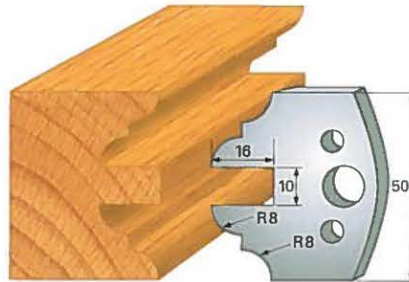

Art. SA2023 - (SA3023)

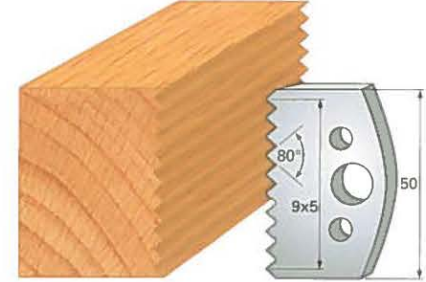

Art. SA2024 - (SA3024)

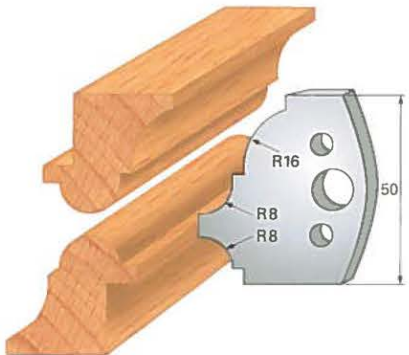

Art. SA2041 - (SA3041)

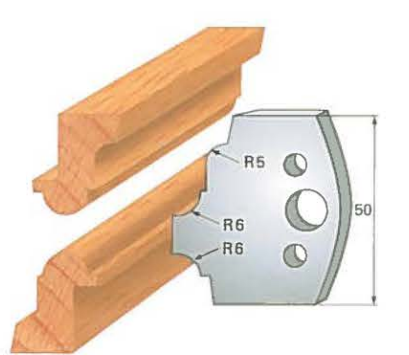

Art. SA2042 - (SA3042)

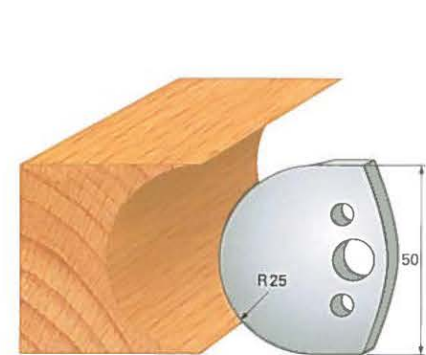

Art. SA2043 - (SA3043)



Art. SA2044 - (SA3044)



Art. SA2045 - (SA3045)

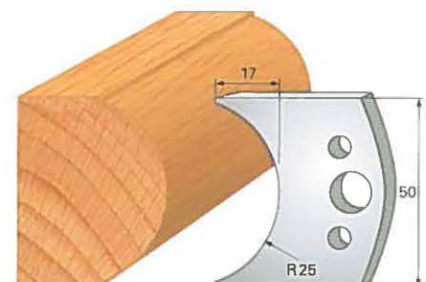

Art. SA2046 - (SA3046)

**STANDARD PROFILE KNIVES IN "SP" STEEL - height 50x4 mm
(RELATING LIMITERS)**

**Example:
Knife SA2.
Limiter (SA3..)**



Art. SA2047 - (SA3047)



Art. SA2048 - (SA3048)

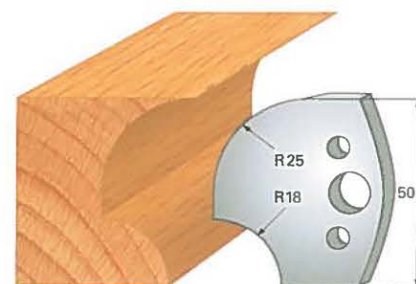

Art. SA2049 - (SA3049)

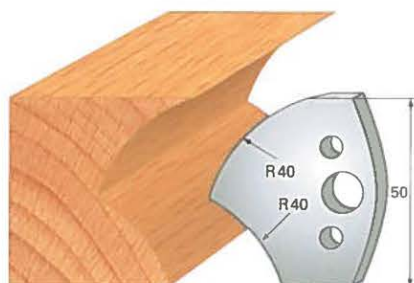

Art. SA2050 - (SA3050)

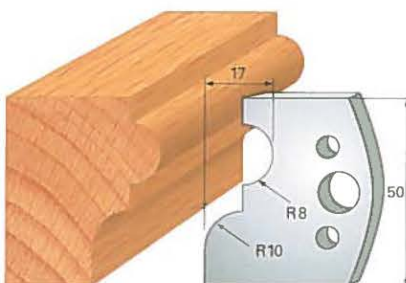

Art. SA2051 - (SA3051)

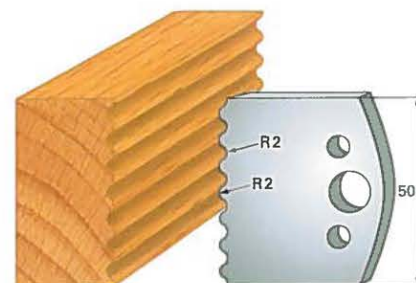

Art. SA2052 - (SA3052)



Art. SA2053 - (SA3053)

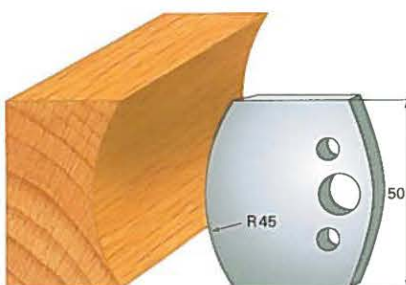

Art. SA2054 - (SA3054)

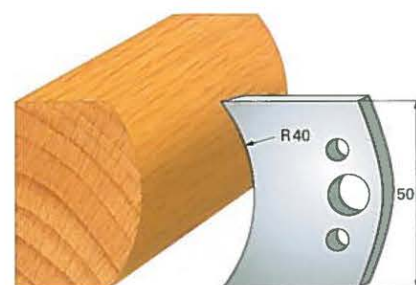

Art. SA2055 - (SA3055)

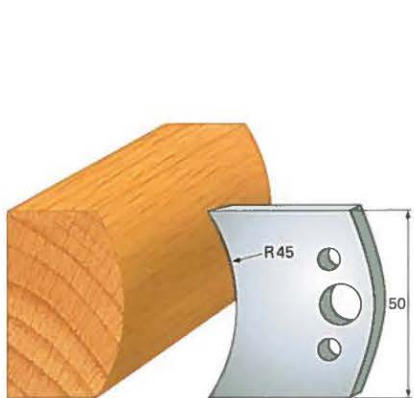

Art. SA2056 - (SA3056)

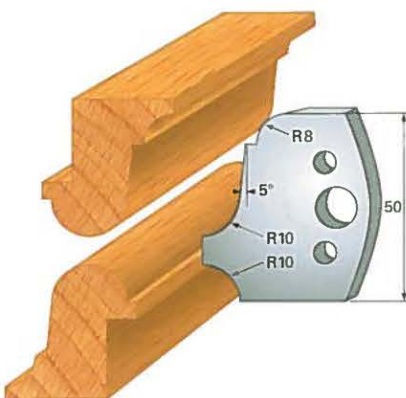

Art. SA2057 - (SA3057)

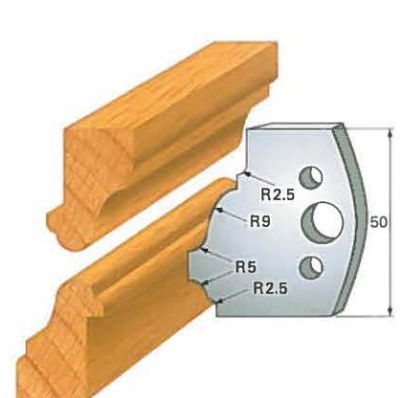

Art. SA2058 - (SA3058)



Art. SA2059 - (SA3059)



Art. SA2060 - (SA3060)

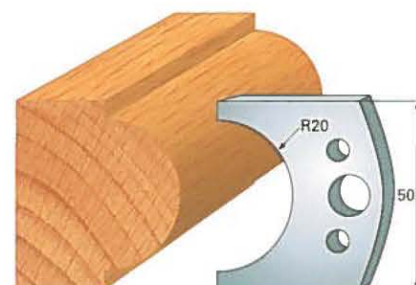

Art. SA2061

**STANDARD PROFILE KNIVES IN "SP" STEEL - height 50x4 mm
(RELATING LIMITERS)**

**Example:
Knife SA2..
Limiter (SA3..)**

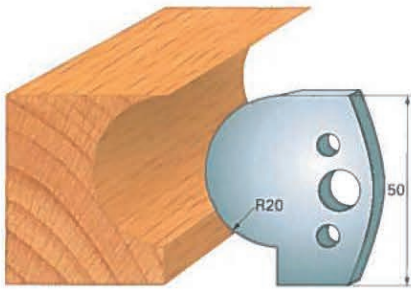

Art. SA2062 - (SA3062)

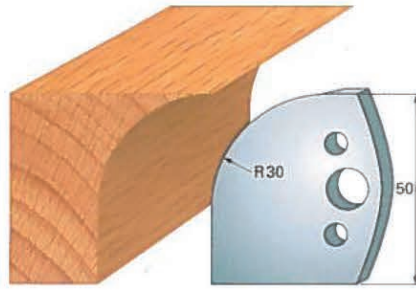

Art. SA2063 - (SA3063)

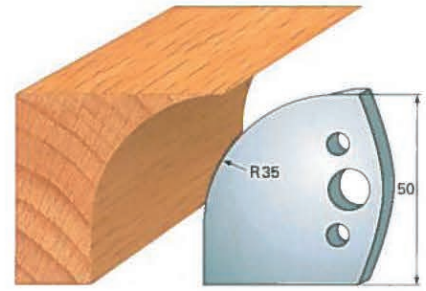

Art. SA2064 - (SA3064)

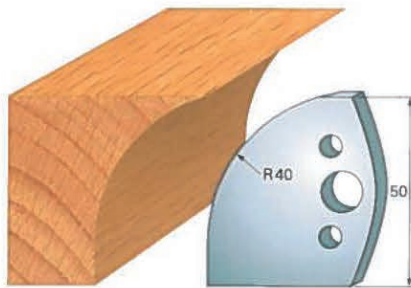

Art. SA2065 - (SA3065)

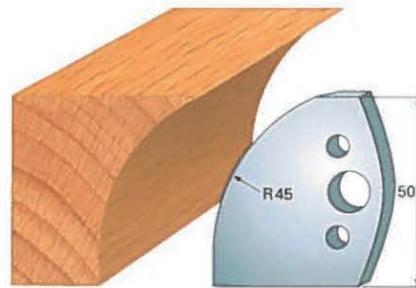

Art. SA20566 - (SA3066)

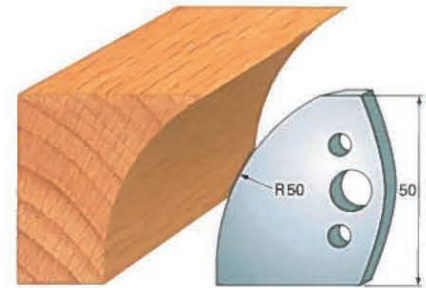

Art. SA2067 - (SA3067)

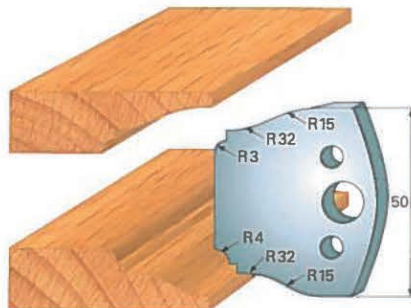

Art. SA2068 - (SA3068)

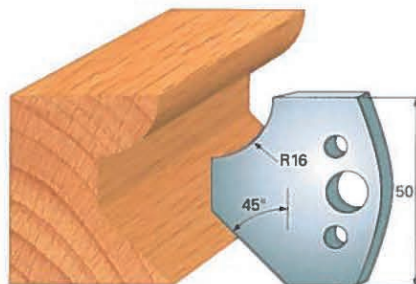

Art. SA2069 - (SA3069)

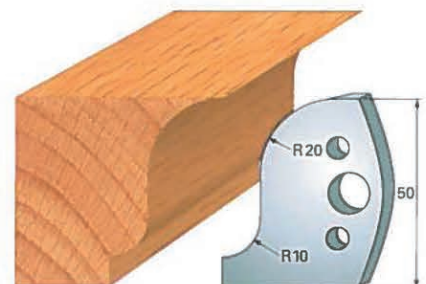

Art. SA2070 - (SA3070)

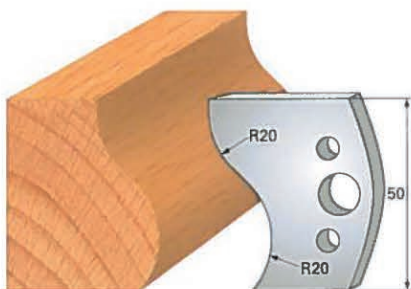

Art. SA2071 - (SA3071)

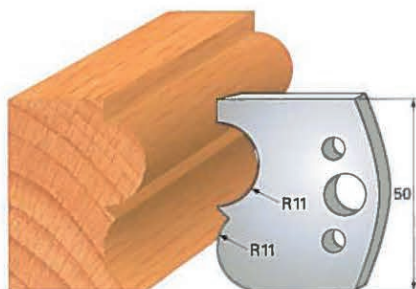

Art. SA20572 - (SA3072)



Art. SA20573 - (SA3073)

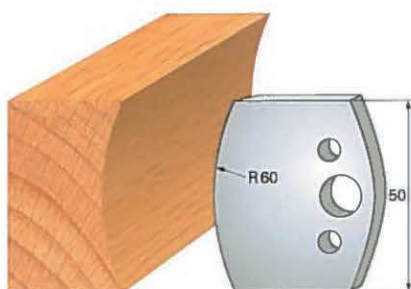

Art. SA2074 - (SA3074)

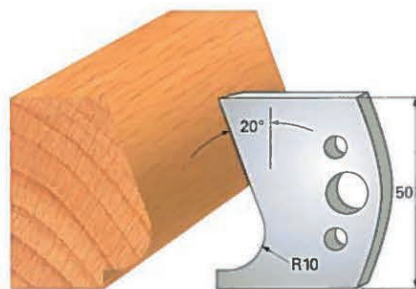

Art. SA2075 - (SA3075)

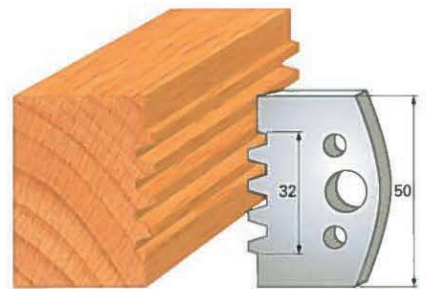

Art. SA2076 - (SA3076)

**STANDARD PROFILE KNIVES IN "SP" STEEL - height 50x4 mm
(RELATING LIMITERS)**

**Example:
Knife SA2..
Limiter (SA3..)**

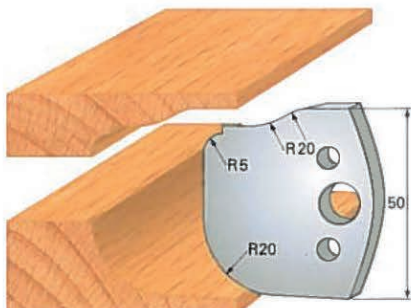

Art. SA2077 - (SA3077)

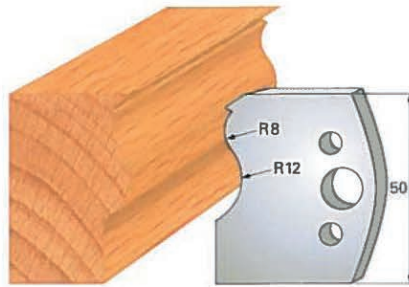

Art. SA2078 - (SA3078)

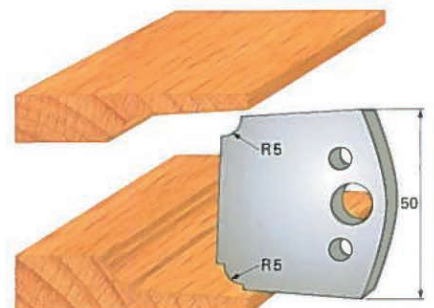

Art. SA2079 - (SA3079)

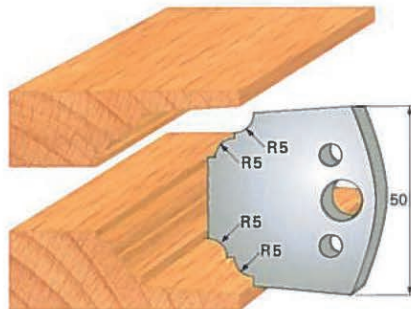

Art. SA2080 - (SA3080)